

# EE 109 Unit 6

## LCD Interfacing



# LCD BOARD

# The EE 109 LCD Shield

- The LCD shield is a \_\_\_\_\_ LCD that mounts on top of the Arduino Uno.
- The shield also contains five buttons that can be used as input sources.

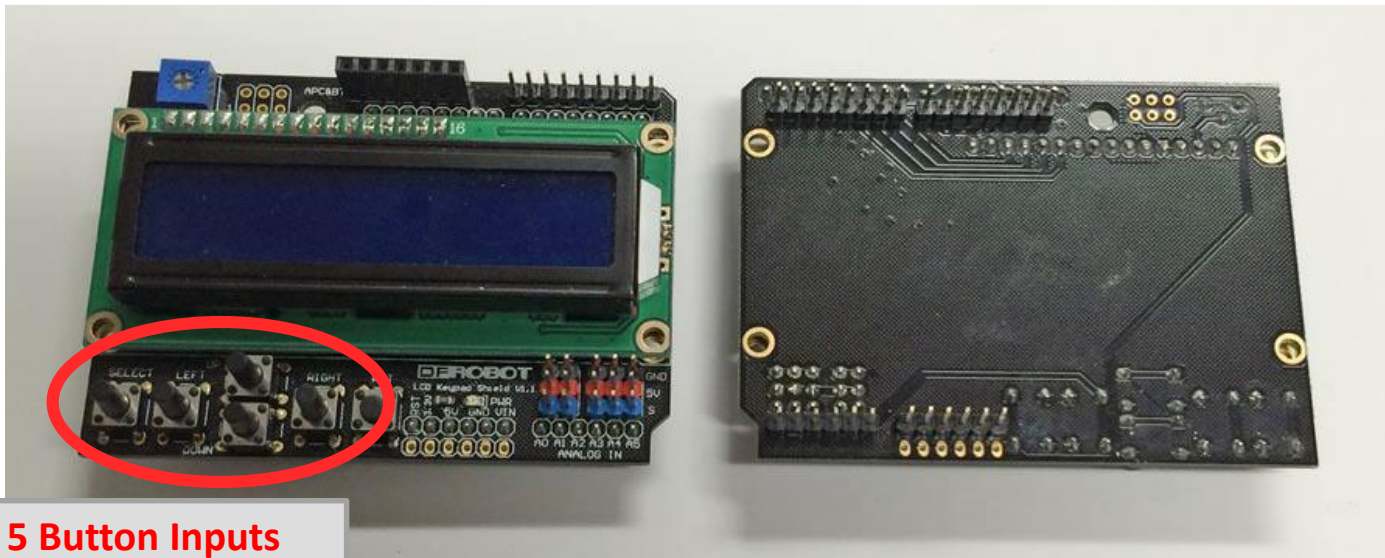

**5 Button Inputs**

# How Do We Use It?

- By sending it \_\_\_\_\_ (i.e. \_\_\_\_\_ one at a time) that it will display for us
- By sending it special \_\_\_\_\_ to do things like:
  - Move the cursor to a \_\_\_\_\_
  - \_\_\_\_\_ the screen contents
  - Upload new fonts/special characters

# How Do We Communicate?

- The LCD uses a "parallel" interface (4-bits sent per transfer) to communicate with the  $\mu\text{C}$  (Note:  $\mu\text{C}$  => microcontroller)
- Data is transferred 4 bits at a time and uses 2 other signals (Register Select and Enable) to control \_\_\_\_\_ the 4-bits go and \_\_\_\_\_ the LCD should capture them

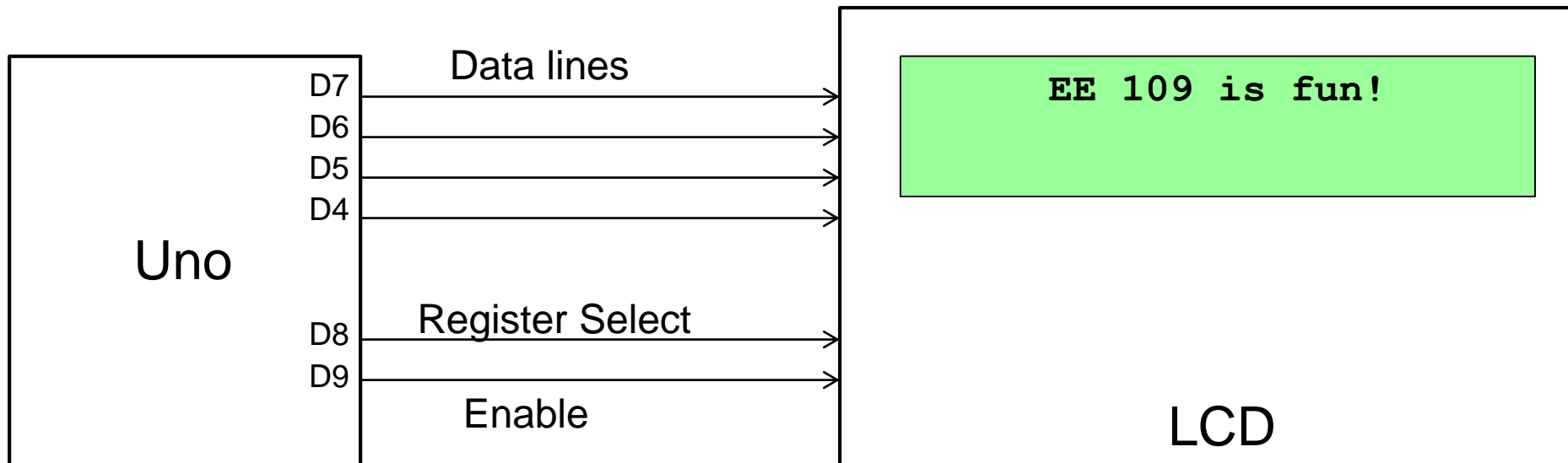

# How Do We Communicate?

- To send an 8-bit byte we must send it in two groups of 4 bits
  - First the \_\_\_\_\_ 4-bits followed by the \_\_\_\_\_ 4-bits
- RS=0 sets the destination as the command reg.
- RS=1 sets the destination as the data reg.

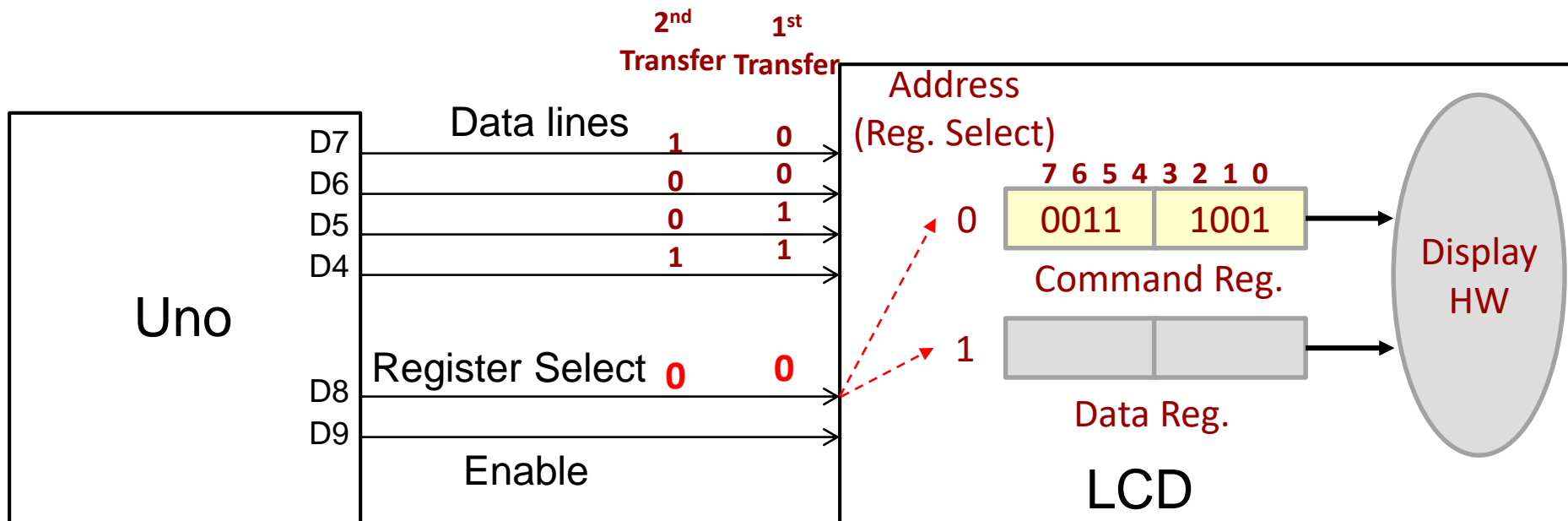

# Commands and Data

- LCD contains \_\_\_\_\_ registers which it uses to control its actions: Command and Data
- A Register Select (RS) signal determines which register is the destination of the data we send it (RS acts like an address selector)
  - RS = \_\_\_\_, info goes into the command register
  - RS = \_\_\_\_, info goes into the data register
- To perform operations like clear display, move cursor, turn display on or off, write the command code to the command register.
- To display characters on the screen, write the ASCII code for the character to the data register.

| Command                             | Code   |
|-------------------------------------|--------|
| Clear LCD                           | 0x01   |
| Cursor Home (Upper-Left)            | 0x02   |
| Display On                          | 0x0f   |
| Display Off                         | 0x08   |
| Move cursor to top row, column i    | 0x80+i |
| Move cursor to bottom row, column i | 0xc0+i |

# How Do We Communicate?

- To send an 8-bit byte we must send it in two groups of 4 bits
  - First the upper 4-bits followed by the lower 4-bits
- RS=0 sets the destination as the command reg.
- RS=1 sets the destination as the data reg.

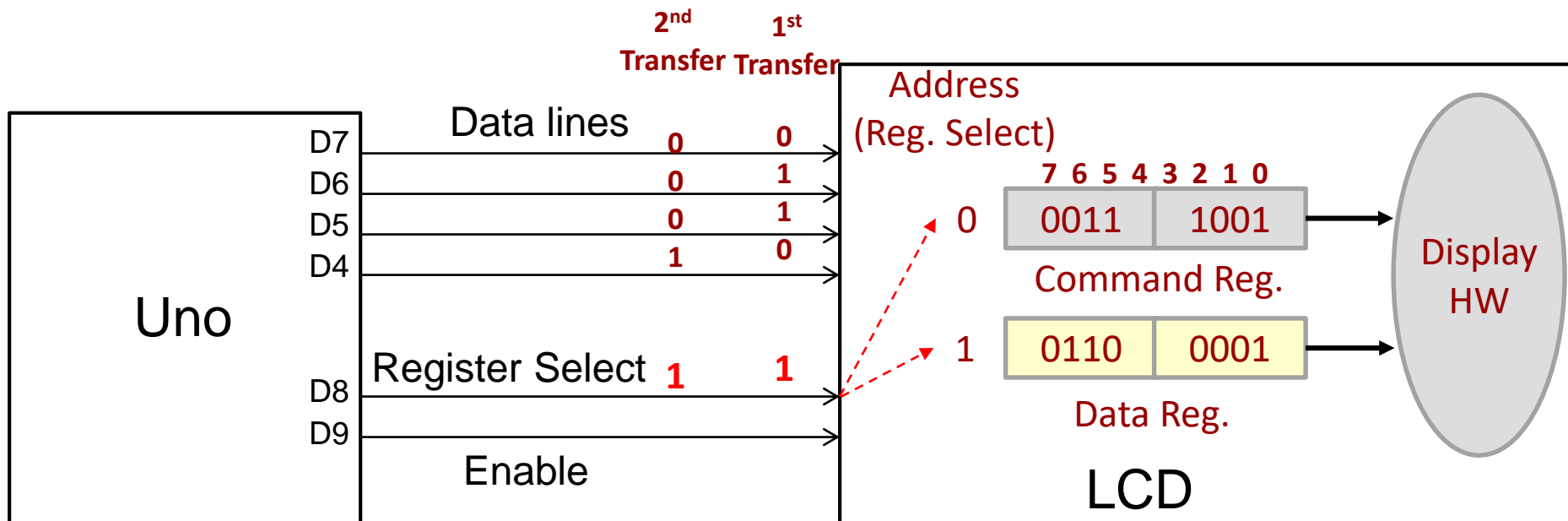



# Another View

- Data from the Uno is transferred by placing four bits on the data lines (Port D bits 7-4).
- The Register Select (RS) line determines whether the data goes to the LCD's "Command Register" or "Data Register"
  - **RS=0** => Command Register                      **RS=1** => Data Register
- The Enable (E) line acts as a \_\_\_\_\_ signal telling the LCD to capture the data and examine the RS bit on the 0-1-0 transition
  - Pulse must be held at 1 for at least 230ns according to LCD datasheet

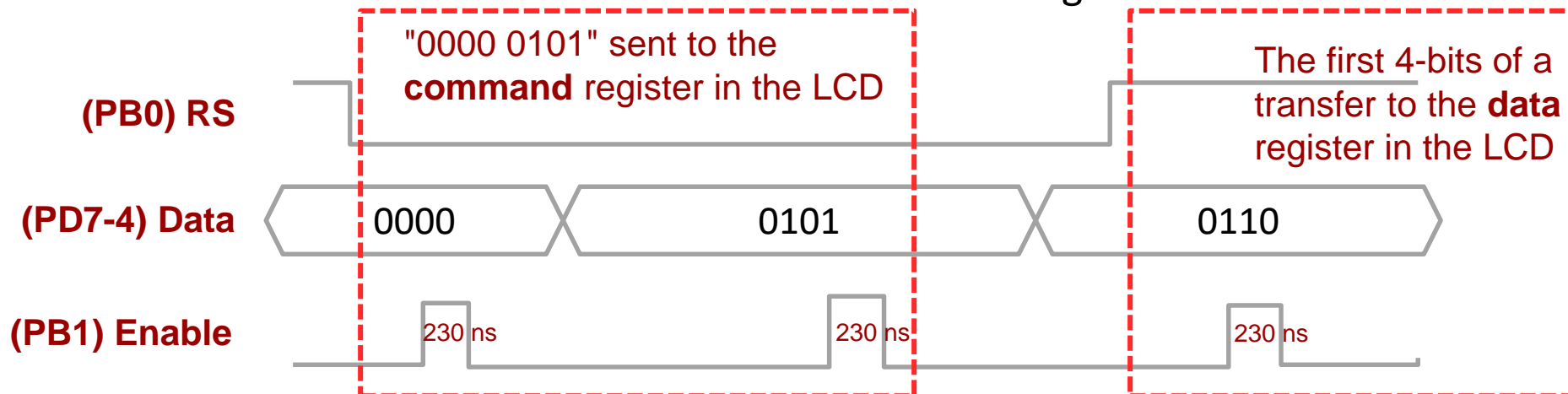

# Another View

- Data from the Uno is transferred by placing four bits on the data lines (Port D bits 7-4)
- Whether sending info to the "command" or "data" register, the LCD still wants a full byte (8-bits) of data so we must do 2 transfers
  - We always send the upper 4-bits of the desired data first
  - Then we transfer the lower 4-bits

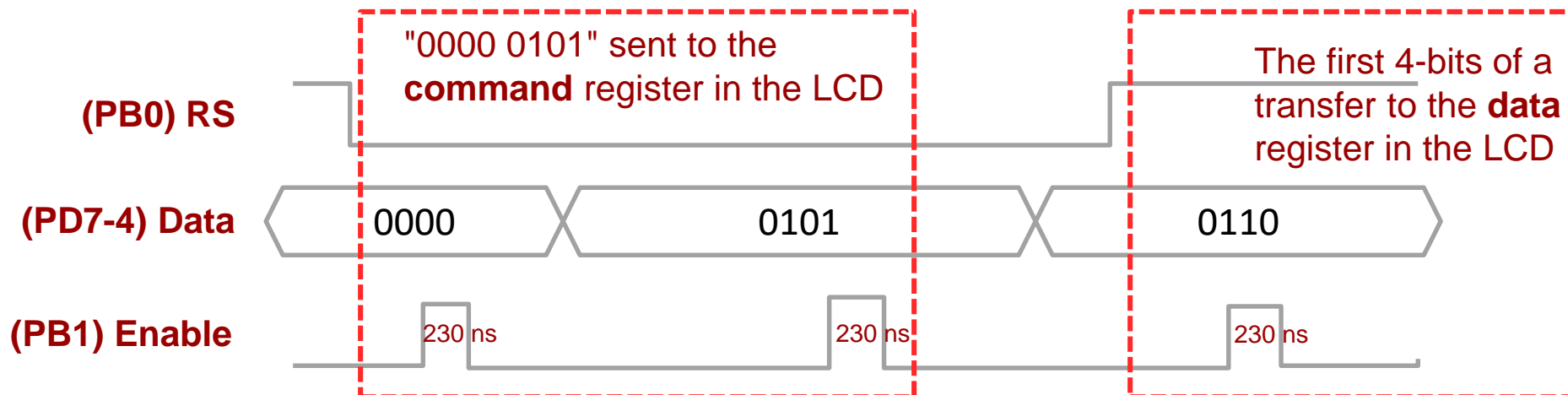

# Who's Job Is It?

- So who is producing the values on the RS and Data lines and the 0-1-0 transition on the E line?
- \_\_\_\_\_!! With your \_\_\_\_\_ (setting and clearing PORT bits)

```
// Turn on bit 0 of PORTD
PORTD |= ____

// Delay 1 us > 230ns needed
// A better way in a few slides
_delay_us(1);

// Turn off bit 0 of PORTD
PORTD &= _____
```

This code would produce some voltage pattern like this on PD0

(PD0)



Note: The LCD connection doesn't use PD0, you'll need to modify this appropriately to generate the E signal

# Other LCD Interface

- Other LCD devices may use
  - Only one signal (a.k.a. serial link) to communicate between the  $\mu\text{C}$  and LCD
    - This makes wiring easier but requires more complex software control to "serialize" the 8- or 16-bit numbers used inside the  $\mu\text{C}$
  - 8-data wires plus some other control signals so they can transfer an entire byte
    - This makes writing the software somewhat easier

# LCD LAB PREPARATION

# Step 1

- Mount the LCD shield on the Uno without destroying the pins
- Download the “test.hex” file and Makefile from the web site, and modify the Makefile to suite your computer.
- Run “make test” to download test program to the Uno+LCD.
- Should see a couple of lines of text on the screen.



# Step 2

- Develop a set of functions that will abstract the process of displaying text on the LCD
  - A set of functions to perform specific tasks for a certain module is often known as an \_\_\_\_\_ (application programming interface)
  - Once the API is written it gives other application coders a nice simple interface to do high-level tasks
- Download the skeleton file and examine the functions outlines on the next slides



# LCD API Development Overview

- Write the routines to control the LCD in layers
  - Top level routines that your code or others can use: \_\_\_\_\_, \_\_\_\_\_, initialize LCD, etc.
  - Mid level routines: write a byte to the command register, write a byte to the data register
  - Low level routines: controls the 4 data lines and E to transfer a nibble to a register
- Goal: Hide the \_\_\_\_\_ about how the interface actually works from the user who only wants to put a string on the display.



# Low Level Functions

- `lcd_writenibble(unsigned char x)`
  - Assumes RS is already set appropriately
  - Send four bits from 'x' to the LCD
    - Takes 4-bits of x and copies them to PD[7:4] (where we've connected the data lines of the LCD)
    - **SEE NEXT SLIDES ON COPYING BITS**
    - Produces a 0-1-0 transition on the Enable signal
  - Must be consistent with mid-level routines as to which 4 bits to send, MSB or LSB
  - Uses: logical operations (AND/OR) on the PORT bits

This will be your challenge to write in lab!

# Mid-Level Functions

- `lcd_writecommand(unsigned char x)`
  - Send the 8-bit byte 'x' to the LCD as a command
  - Set RS to 0, send data in two nibbles, delay
  - Uses: `lcd_writenibble()`
- `lcd_writedata(unsigned char x)`
  - Send the 8-bit byte 'x' to the LCD as data
  - Set RS to 1, send data in two nibbles, delay
  - Uses: `lcd_writenibble()`
- Could do as one function
  - `lcd_writebyte(unsigned char x, unsigned char rs)`

**This will be your challenge to write these two functions in lab!**

# High Level API Routines

- `lcd_init()`
  - Mostly complete code to perform initialization sequence
  - **See lab writeup for what code you MUST add.**
  - Uses: `lcd_writenibble()`, `lcd_writecommand()`, `delays`
- `lcd_moveto(unsigned char row, unsigned char col)`
  - Moves the LCD cursor to “row” (0 or 1) and “col” (0-15)
  - Translates from row/column notation to the format the LCD uses for positioning the cursor (see lab writeup)
  - Uses: `lcd_writecommand()`
- `lcd_stringout(char *s)`
  - Writes a string of character starting at the current cursor position
  - Uses: `lcd_writedata()`

# Activity: Code-Along

- Assuming the `lcd_writecommand()` and `lcd_writedata()` functions are correctly written, code the high-level functions:
  - `void lcd_stringout(char* str);`
  - `void lcd_moveto(int row, int col);`

To implement `writenibble()` these slides will help you...

## **COPYING BITS**

# Copying Multiple Bits

- Suppose we want to copy a portion of a variable or register into another BUT \_\_\_\_\_ affecting the other bits
- Example: Copy the lower 4 bits of X into the lower 4-bits of PORTB...but leave the upper 4-bits of PORTB UNAFFECTED
- Assignment \_\_\_\_\_ work since it will overwrite ALL bits of PORTB
  - `PORTB = x; //` changes all bits of PORTB

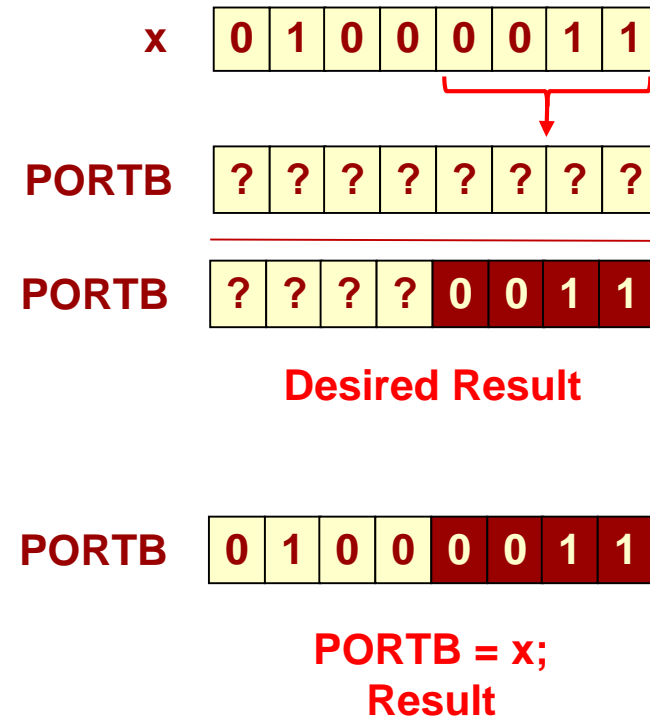

# Copying Into a Register

- Solution...use these steps:
- Step 1: Define a \_\_\_\_\_ that has 1's where the bits are to be copied  

```
#define MASKBITS 0x0f
```
- Step 2: \_\_\_\_\_ those bits in the destination register using the MASK  

```
_____ &= ~MASKBITS
```
- Step 3: Mask the appropriate field of x and then \_\_\_\_\_ it with the destination, PORTB  

```
PORTB |= _____
```

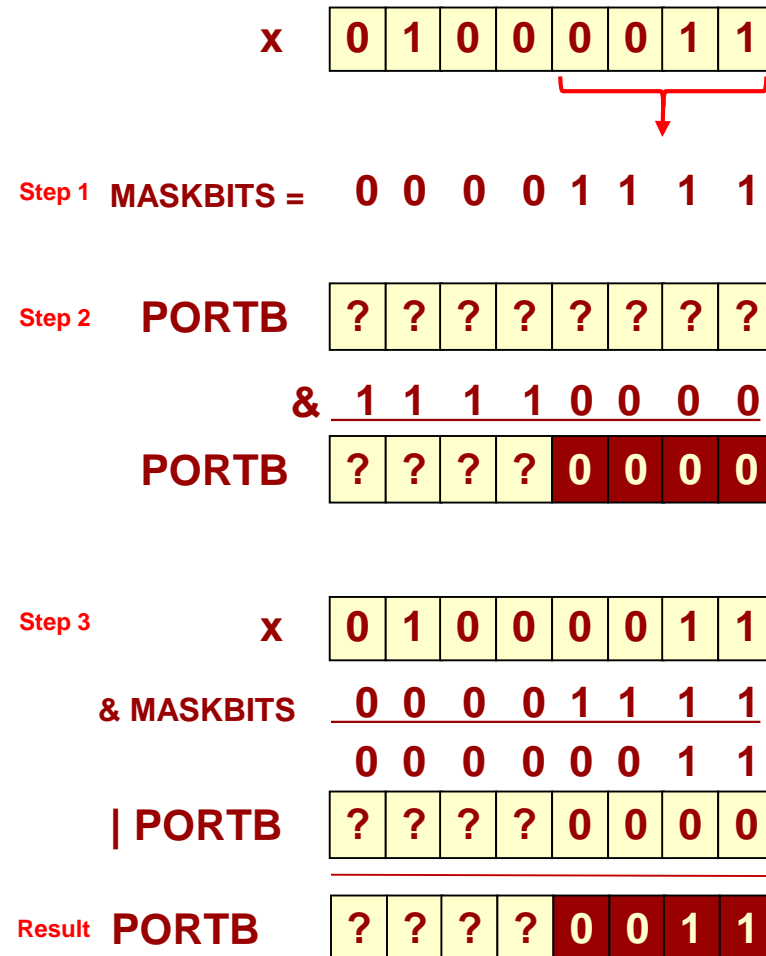

# Do We Need Step 2...Yes!!!

- Can't we just do step 1 and 3 and OR the bits of x into PORTB

```
#define MASKBITS 0x0f
PORTB |= (x & MASKBITS);
```

- \_\_\_\_, because what if the destination (PORTB) already had some 1's where we wanted 0's to go...

- ...Just \_\_\_\_\_ wouldn't change the bits to \_\_\_\_\_

- That's why we need step 2
  - Step 2: Clear those bits in the destination register using the MASK

```
PORTB &= ~MASKBITS;
```

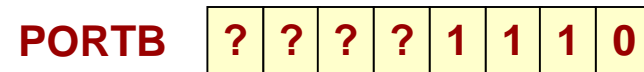
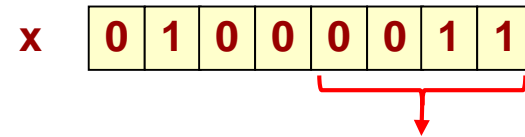

What if PORTB just happened to have these bits initially

Step 1 & 3

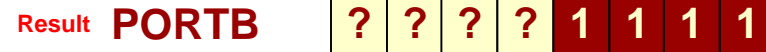
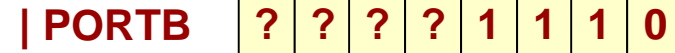
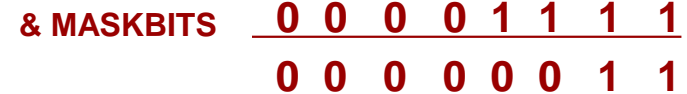
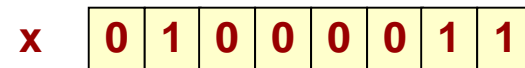



# Copying To Different Bit Locations

- What if the source bits are in a different location than the destination
  - Ex. Copy lower 4 bits of x to upper 4 bits of PORTB
- Step 1: Define a mask that has 1's **where the bits are to be copied**

```
#define MASKBITS 0xf0
```
- Step 2: Clear those bits in the destination register using the MASK
 

```
PORTB &= ~MASKBITS
```
- Step 3:            the bits of x to align them appropriately, then perform the regular step 3
 

```
PORTB |= ((          ) & MASKBITS);
```

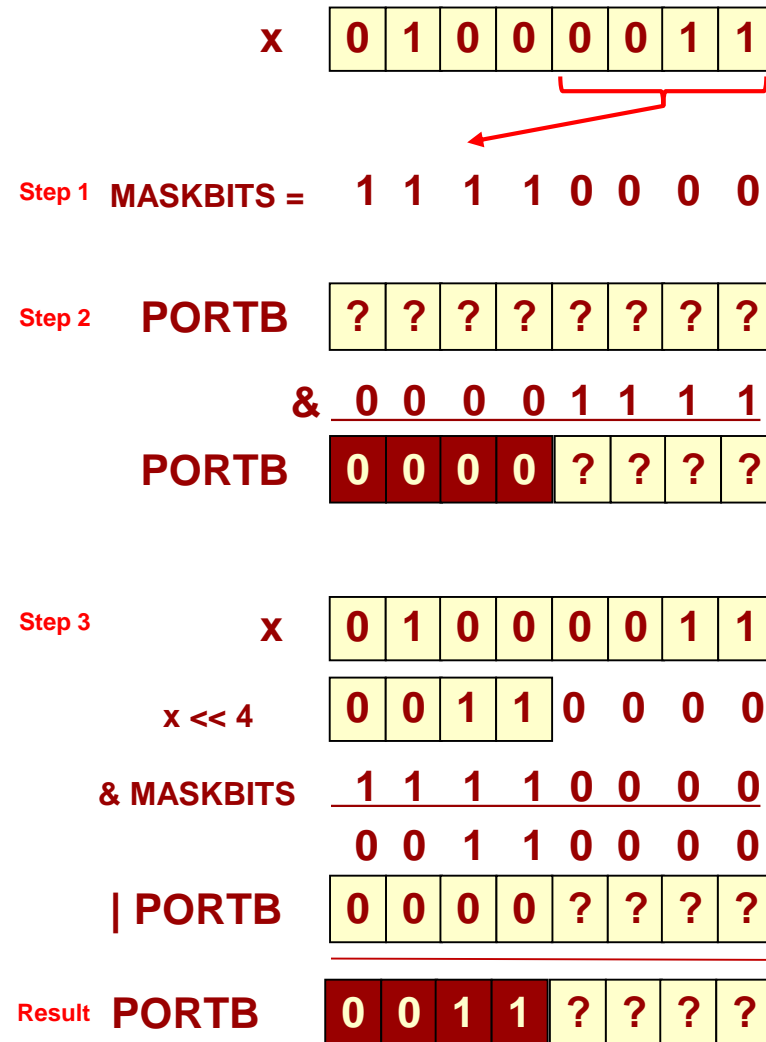

# Coding a Byte Transfer to the LCD

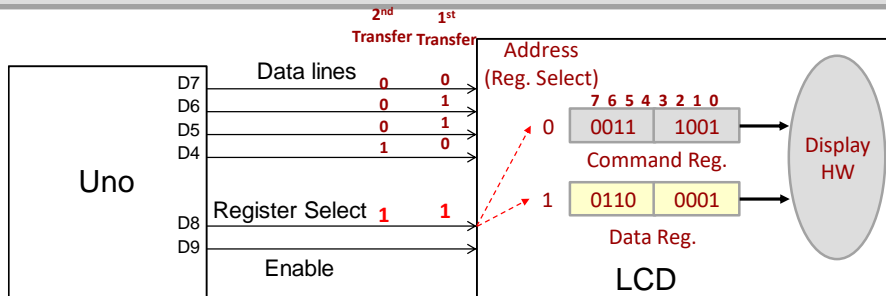
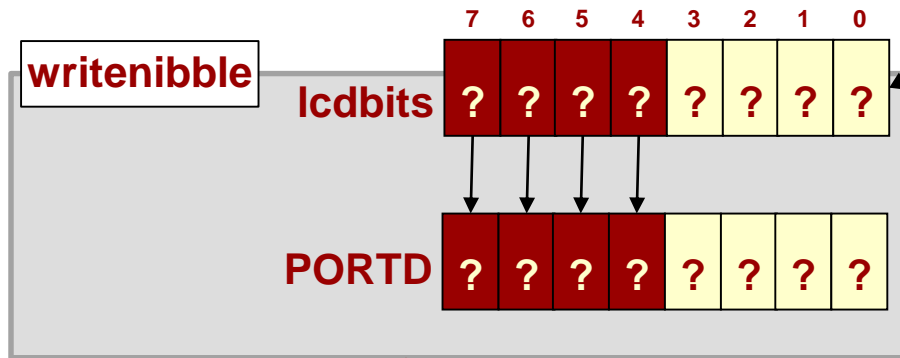
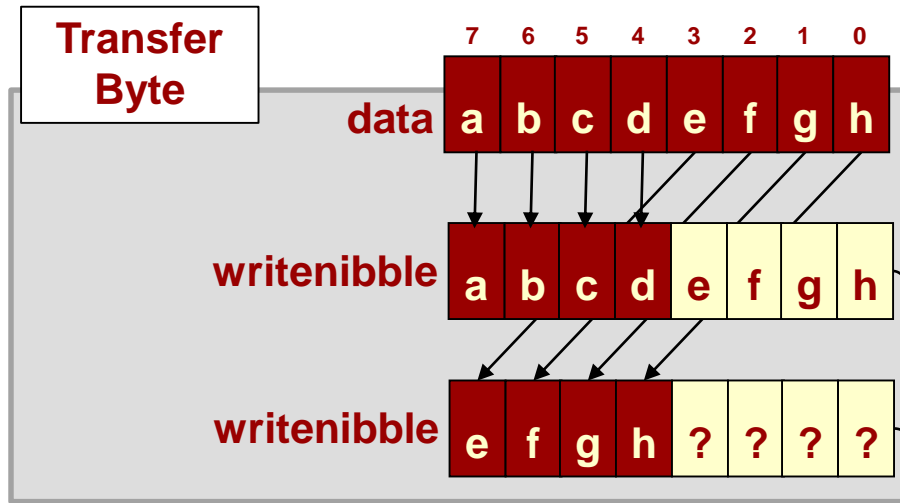

Ensuring the Enable pulse is long enough

**THE DEVIL IN THE DETAILS...**

## Making Things Work Together

### Does your code do the right thing?

- LCD lab required the program to generate an Enable (E) pulse.
- Example: The `writenibble()` routine controls the PB1 bit that is connected to the LCD Enable line.

```
PORTB |= (1 << PB1);    // Set E to 1  
PORTB &= ~(1 << PB1);  // Clear E to 0
```

- Creates a  $0 \rightarrow 1 \rightarrow 0$  pulse to clock data/commands into LCD.
- But is it a pulse that will work with the LCD?
- Rumors circulated that the E pulse had to be made longer by putting a delay in the code that generated it.
- Don't Guess. Time to read the manual, at least a little bit.

# Making Things Work Together

## Check the LCD controller datasheet

### Timing Characteristics

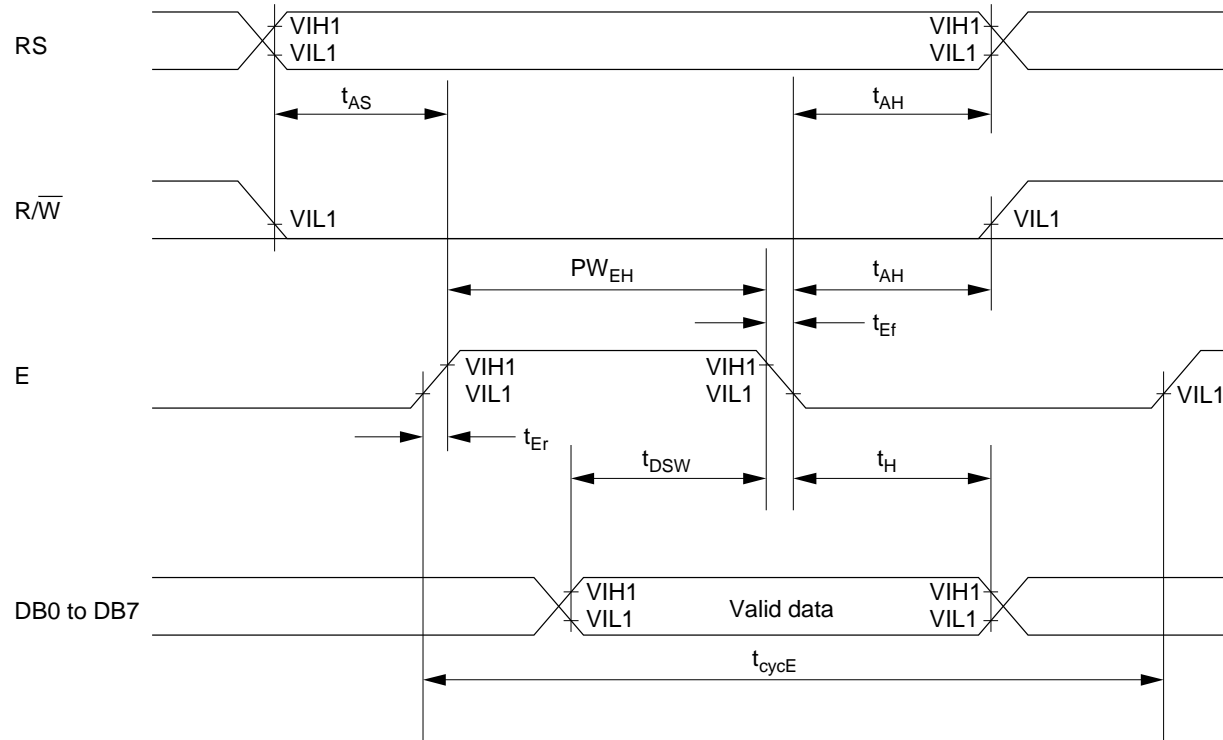

Figure 27 Write Operation

## Making Things Work Together

### Check the generated code

- Can check the code generated by the compiler to see what is happening.
- For the creation of the E pulse the compiler generated this code:

```
SBI  PORTB, 1    ; Set Bit Immediate, PORTB, bit 1
```

```
CBI  PORTB, 1    ; Clear Bit Immediate, PORTB, bit 1
```

- According to the manual, the SBI and CBI instructions each take 2 clock cycles
- 16MHz  $\Rightarrow$  62.5nsec/cycle, so pulse will be high for 125nsec

# Making Things Work Together

## Check with the oscilloscope



# Making Things Work Together

## Extend the pulse

- At 125nsec, the E pulse is not long enough although it might work on some boards.
- Can use `_delay_us()` or `_delay_ms()` functions but these are longer than needed since the minimum delay is 1 us (=1000 ns) and we only need 230 ns
- Trick for extending the pulse by a little bit:

```
PORTB |= (1 << PB1);    // Set E to 1
PORTB |= (1 << PB1);    // Add another 125nsec to the pulse
PORTB &= ~(1 << PB1);  // Clear E to 0
```



# Making Things Work Together

## Better looking pulse

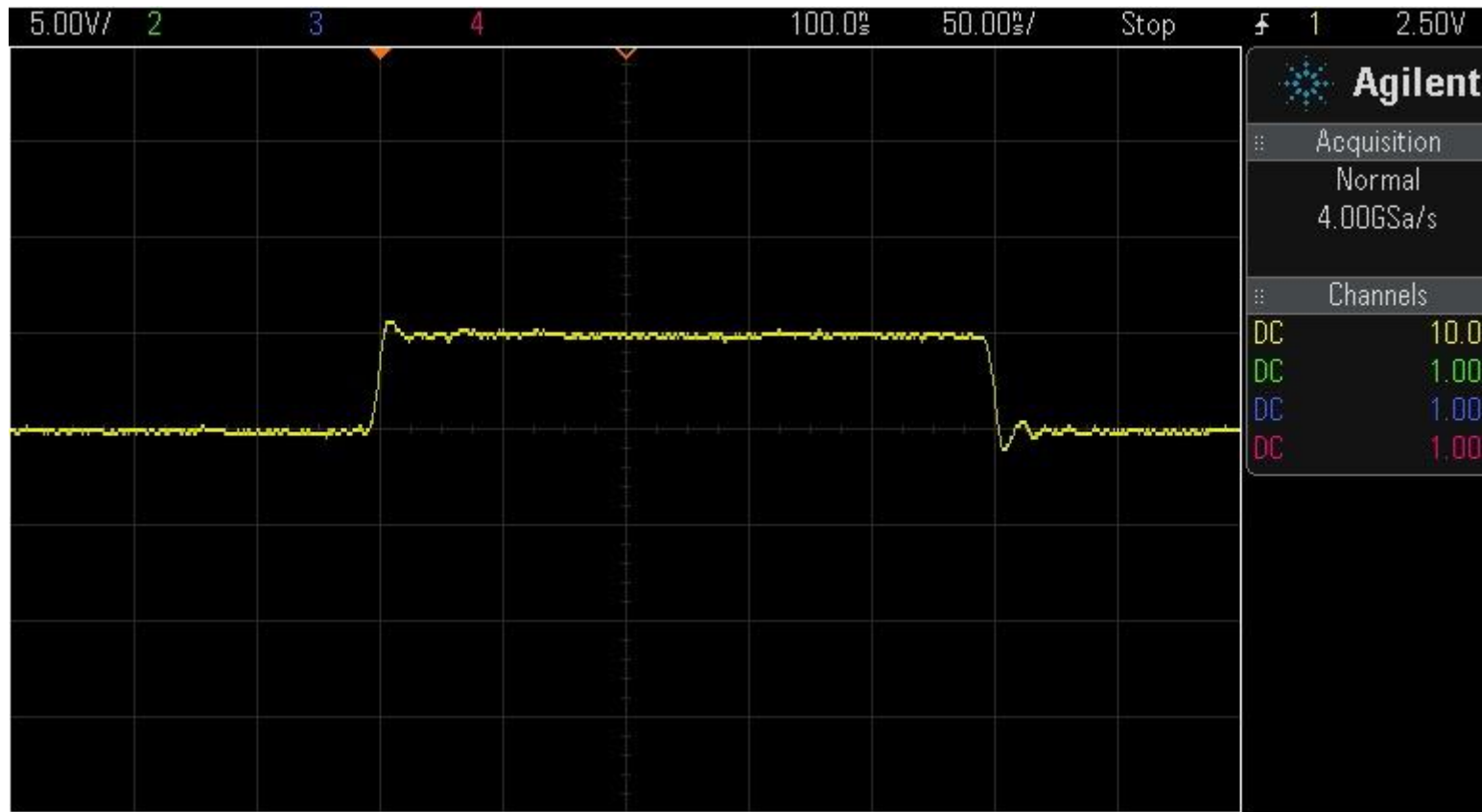

## Making Things Work Together

### Extend the pulse (geek way)

- Use the “asm” compiler directive to embed low level assembly code within the C code.
- The AVR assembly instruction “NOP” does nothing, and takes 1 cycle to do it.

```
PORTB |= (1 << PB1);    // Set E to 1
asm("nop");            // NOP delays another 62.5ns
asm("nop");
PORTB &= ~(1 << PB1);  // Clear E to 0
```

## Making Things Work Together

### Don't guess that things will work

- When working with a device, make sure you know what types of signals it needs to see
  - Voltage
  - Current
  - Polarity (does 1 mean enable/true or does 0)
  - Duration (how long the signal needs to be valid)
  - Sequence (which transitions comes first, etc.)
- Have the manufacturer's datasheet for the device available
  - Most of it can be ignored, but some parts are critical
  - Learn how to read it
- When in doubt → follow the acronym used industry-wide: RTFM (read the \*!@^\*-ing manual)